



Publication of the  
Northern California  
Contest Club



#614 – September 2023

## NCCC – 53 years of contesting excellence

### Inside This Issue

- President's Report
- About the NCCC
- VP/CC Report
- Pacificon 2024 Needs You**
- How I Spent My Summer
- Mammoth Meeting Held
- On-line Score Reporting for N3FJP
- Morse Code Saves the Day
- Tube of the Month
- California QSO Party
- Editor Notes
- Solar X-Ray Machine
- NCCC Lands End Store
- Elecraft Display Ad
- HRO Display Ad

#### **NCCC MEETING**

<https://nccc.cc/meetings.html>

Next Meeting Tue 12 Sep  
**Wagon Wheel BBQ + Zoom**  
861 Leong Drive  
Mountain View, California 94043

**“WRTC 2022 [Italy, 2023]”**  
Alan, AD6E/KH6TU – Bob, K6XX

### President's Report

David, KO6M



Contesting Season 23/24.... Where will it bring you? Over the next several months we have all the contests that inspire us to do what we do. CW, RTTY, SSB. All a given their own unique opportunities to allow us to get on the air and operate. I challenge you to do 10% better than you did last year in any given contest. Make that a contest for yourself. Base it on points, QSOs, butt in chair time, etc.... just do 10% better in some way than you did last year. I'll raise my challenge: do 10% better In each contest. Why do it once and then move on? Do it the whole season. See what it does for your overall scores. See what it does to your KB award status. See what happens to our club scores (you are submitting for NCCC right?). Most importantly see what happens to your fun factor.

I'll let Chris speak to the upcoming contests, but I thought I should mention that Sweepstakes were previously a big focus for the club. I believe it can be again. The single most important part of that would be getting on the air and then submitting logs. I know full well how hard it can be to manage the radio/life balance when a contest is a full weekend. Couple that with how slow things get or how late things can go. It can be a recipe for disaster. So, here's what I recommend

Mark the weekend of November 4<sup>th</sup> and November 18<sup>th</sup> down as CW and SSB.

Bonus points for marking the weekend of December 9<sup>th</sup> down as 10M.

Remind your loved ones that you've got things to do those weekends.



Just randomly say it every now and then.

If you know you can't commit to the whole weekend, just plan on Sunday as your BIC day. Being fresh meat has benefits.

Submit your logs with "Northern California Contest Club" as your club

In just about a month (depending on when you read this) we will have CQP (October 7-8). Thank you to Dean for giving us the presentation last month about CQP and various operating strategies. This is a contest I always look forward to. To me it's the big one. Why? Why not Sweepstakes or WPX? I'll tell you why, because it's the one time California takes center stage.

In conclusion, that I say go forth and call CQ! Get on the air and have fun.

## About NCCC

### Officers and Directors, 2023-2024 Contest Season

President: David West, [KO6M](#)

Vice-President/Contest Chairman: [Chris Tate, N6WM](#)

Secretary: Greg Alameda, [KK6PXT](#)

Treasurer: [Nian Li, WU6P](#)

Past President: [David Jaffe, WD6T](#)

Director: Bob Cox, [K3EST](#)

Director: [John Miller, K6MM](#)

Director: Ed Radlo, [AJ6V](#)

### Volunteers

Charter Member: Rusty Epps, [W6OAT](#)

Awards Chair: Gary Johnson, [NA6O](#)

California QSO Party Chair: Dean Wood, [N6DE](#)

QSL Mgr [\[K6ZM\]](#): vacant

QSL Mgr [\[K6CQP/N6CQP/W6CQP\]](#): Ed Muns [W0YX](#)

NAQP Teams: Fred Jensen, [K6DGW](#)

NA CW Sprint Teams: Bob Vallio, [W6RGG](#)

NCCC Email Reflector Admin: Phil Verinsky, [W6PK](#)

Worked All CA Counties Award: Fred Jensen, [K6DGW](#)

### NCCC Thursday Night Contesting

NCCC Sprint: Tom Hutton, [N3ZZ](#)

NS CW Ladder: Bill Haddon, [N6ZFO](#)

NS RTTY Sprint/Ladder: Ed Radlo, [AJ6V](#)

### Communications

Webmaster: John Miller, [K6MM](#)

Webinars: Bill Fehring, [W9KKN](#)

Membership: Gary Johnson, [NA6O](#)/Ian Parker, [W6TCP](#)

### JUG Editor

Fred Jensen, [K6DGW](#): [k6dgwnv@gmail.com](mailto:k6dgwnv@gmail.com)

Home: 775.501.5488

Cell: 530.210.0778

## VP/CC Report

**Chris, N6WM**



Greetings fellow Northern California Contesters.

**The contest Season is upon us!**

Yeah its that time.. as we cruise through the fall its time to start thinking about the 2023-2024 primary contest season!

This could be a season of greatness. There is little doubt we are approaching the solar peak and although it brings with it some periodic disruption to the HF bands, it also grants us things like excellent propagation, and wide open upper bands like 10 meters. This can change operating strategies and I suggest as we roll into the season that it's worth thinking about a strategy that includes a solid plan for 10 and 15 meters..

### **The All Asia SSB contest – A mixed bag but fun**

Over the weekend of 9/3 I had the pleasure of operating the All Asia SSB contest with veteran contesters Bob Cox K3EST, Ken N6RO as well as one of our newest members Greg KK6PXT. Participation seemed a bit low this year, and there were certainly some solar events that made the contest challenging. But there were a couple of things that gave the cloud a silver lining. First, since all operators were on site, we were able to have some great conversations, and the in shack camaraderie was great, including a great new Chili spin by Ken to keep us fed,



and lots of good conversation with all members. Secondly to the patient come the spoils ... on Saturday it seemed that the contest was going to be a bust (despite the good conversation). But it became clear on Sunday that conditions were rapidly improving and to that avail, the 15 meter band came alive producing over a hundred more qsos with a modest JA run in the last 3 hours of the contest. So it was an interesting weekend filled with contesting conversation and topped off with some good runs!

**Time for the big warm up for the season – RTTY style.**

Run on the last weekend of September annually, the CQ Worldwide DX Contest RTTY is rapidly approaching. With over 15,000 logs submitted annually, this is truly the mother of all RTTY contests. The NCCC has been a pioneering organization with regard to the rtty mode and is home to some of the greatest RTTY operators in the world. RTTY contesting is firmly in the DNA of this club, and I hope that most of you will get on the air. Heck if you are already doing FT\* contesting, your setup is basically ready for using the rtty mode, and there are plenty of resources out there to assist. Please check the website for rules and tools to get qrv at <https://cqwwrtty.com/>

**The California QSO party – activate a county.. get on the air, BE THE DX!**

Another contest that is firmly in the DNA of the NCCC membership is the California QSO party. Under its leadership by Dean N6DE and a dedicated team of volunteers, working on promotion, interesting changes, and

**Fun Contest !**

**California QSO Party**  
October 7-8, 2023

- 160-10M
- CW & SSB
- 40 Awards
- Club Competition
- Get on the air and have some fun!

**Rules & Info:**  
**CQP.org**





keeping the event strong, there is plenty of fun to be had. I hope each and every one of you have a plan to be on the air for this amazing event. This is THE qso party that defines all others so make sure you are a part of it! Its coming up fast on 10/7 2023 so go over to the website and get up to speed and register your operation, <http://cqp.org>

So to all, Enjoy the Solar Peak, and enjoy your 2023-2024 contest season

73 and seeya next time Chria N6WM

## **Pacificon 2024 Needs You!**

**Kristen McIntyre K6WX**  
**ARRL Pacific Division Director**

Pacificon is the premier West Coast ham radio convention. Each October, Amateurs gather for all of the things we love like vendors, technology demonstrations, youth activities, license classes, special event stations, Wouff Hong, the swap meet, breakfast with Gordo, the Saturday Banquet, the ARRL Forum, the Antenna Forum, world-class talks, a chance to be with old friends and new, and more. Pacificon is also the ARRL Pacific Division Convention, which means it's near and dear to me as your Division Director.

All of this could go away. That's why I need your help. The Mount Diablo Amateur Radio Club (MDARC) has been the sponsor of this event for many years, and will continue to be the main sponsoring club. They have provided the leaders that make things happen from within their membership. The current Pacificon leadership has worked extraordinarily hard for many years to bring us the excellent experience we have all had. These amazing volunteers have, however, indicated that it's time for them to retire. Starting next year, they are ready to pass this leadership torch on to others in the ham radio community, inside or outside MDARC, who can continue to bring this event to us and grow it into the future.

This is where you come in. In this Year of the Volunteers, I want to encourage you to reach one rung higher and consider taking on one of the leadership roles that need to be filled to continue bringing Pacificon to you. If you are at all curious about what we need, please contact me and I will be happy to fill you in and put you in contact with the right people. This is an urgent need, as planning for Pacificon 2024 starts in just a few months.

be one of those. Help MDARC and me keep this event healthy for years to come. You can contact me at [k6wx@arrl.org](mailto:k6wx@arrl.org).





## WRTC Chronicles

### “How I Spent My Summer Vacation”

Alan, AD6E/KH6TU/I44Z



Does that remind you of 5<sup>th</sup> grade English class?

I've traveled the world for business and ham radio and seen many things, but none could equal being a contestant at WRTC 2022 in Bologna, Italy in July. I'm still a bit shocked that I even managed to get invited to such a prestigious event. I have a fun time playing in contests as I have done for many years, but I've never taken it seriously. I've never WON a contest.

First, a little about me. I was Noviced (verb) in high school in 1962 and learned the basic ropes on the novice bands with a Heath AT-1 and an S38E. Truth be told, the novice experience taught me a whole lot of bad operating practices, but somehow I managed to graduate into the General bands after flunking the FCC code test ... once. CW has never been my strong suit, but the 2<sup>nd</sup> try succeeded. Being young, you learn by failing. I suppose that's true at any age but it didn't take long to learn NOT to become part of the keying circuit in a 6L6 cathode keyed transmitter. And many other lessons learned. I heard about this contest called Sweepstakes and got into it with relish. After two weekends of CW SS, I sent in my log with 62 QSOs and a few more lessons learned.

I dropped out of ham radio in college. When drafted, they found out I knew some Morse and sent me to the Philippines to operate the military CW net (but mostly RTTY). After that it was raising a family and grad school so ham radio wasn't part of my life until the late '80s. Somehow I heard about “packet radio” and bought a modem and found an old 2 meter radio. There, I ran into Rusty, W6OAT who asked if I did any contests. I told him about my SS attempt years ago and a couple of Field Days. He invited me to an NCCC meeting.

A few years later, I was operating SS CW – a little better than my first time, but not a lot. I moved to 80 meters and my TS930 was wiped out by an extremely loud signal. Not dirty, just extremely loud. It was N6IP (now K6XX) who was living about 5 blocks away in NE San Jose. I invited him to an NCCC meeting.

I moved to Maui in 2014 and got HOA approval for a 72ft crankup. It's very quiet here so operating from KH6 is 40 dB more fun than operating in noisy San Jose. Still, I always set my contest goals to be fairly easy to achieve. I push myself a bit but I really only contest to attract high rates. Working a pileup is a rush. As Kenny K2KW once said “I have a rate addiction and need that occasional fix”. I too have that affliction. I QRV when the band is really open for that high rate fun but then go mow the lawn when it sags off. So, I don't win anything, but I have fun. I've operated on DXpeditions like K7C (Kure), 3D2C (Conway), T33A, KH9, TX3X, TI9M, and a couple others. I do only CW and push the rate as high as I can. My goal is the 200/hour mark. That's difficult when you have a 15 kHz wide pileup. I'm pretty comfortable handling a pileup from the DX side.

The first ham I met after moving here was Kent, KH6CJJ. He lives in the same subdivision about ½ mile south of me and keeps a low profile since the HOA rule is “antennas must be under 4 feet”. It's actually a rule to keep TV and satellite dishes off of roofs. Kent has a “triband & wires” antenna farm and does rather well. He has much better BIC ability than I do. He also ONLY operates low power. There are few contesters in Hawaii and we almost all use amplifiers. As such, Kent almost always wins the low power category for the state.



When “Contact Sport” by J.K. George came out, Kent was fascinated by it and decided to push for qualification in 2022. Qualification is a two year process where you get qualification points by how well you finish a qualifying event (CQWW, ARRL DX, RDA, WPX, etc). Since Kent only operates low power, he was getting a lot of qualifying points by winning the low power category. After the first year, he told me that I should try harder because he wanted to pick me as his Team Mate. I did a little harder and at the end of the qualifying period, Kent was in 1<sup>st</sup> place and I was (barely) in 2<sup>nd</sup> place with only half of Kent's score. Kent was sent an invitation to participate as Team Leader by the Italians. He then picked me as his Team Mate.

Kent is a retired Air Force officer and not technically inclined. I took responsibility for our WRTC station design although I had no WRTC experience. I knew what was needed, but in retirement I've given up my EE tools, work bench, etc. I turned to someone I knew had some very good experience and contacted Bob K6XX for help. Bob was a competitor in the two previous WRTCs and I knew he had the necessary equipment. Bob is an excellent design engineer at Elecraft and I've known him for a long time. He agreed to help and to provide some if not all the needed equipment. That included a triplexer, automatic control logic, audio recording, referee support, etc. All that is NOT trivial.

WRTC 2022 was postponed a year due to Covid. Kent said he would turn 80 years old one week after the event and was unsure if he could travel to Italy. I gave Bob a heads up that if Kent could not make the trip, then I would become Team Leader and would select him to be my Team Mate. Sometime in December last year, Kent formally withdrew. It was a disappointment, but his health and ability to travel was a concern.

The first thing Bob did was to bring in his support team from the last WRTC in Germany. That included Don, K6GHA and Tom, KW6S. Tom designed and built the antenna switching and routing boxes as well as the audio processing for recording two radios at once and feeding the stereo audio to the referee. That was already in process before Kent had to drop out. The Italians wanted us to supply a block diagram of what we were going to do and to insure we were following all the rules. This is what we supplied.

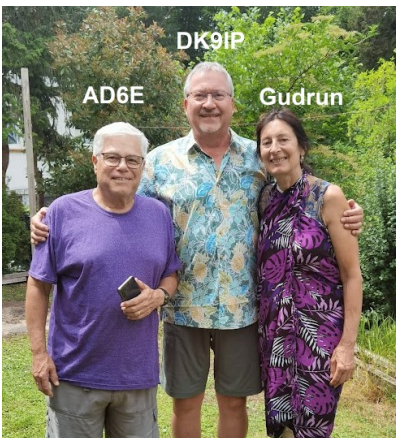
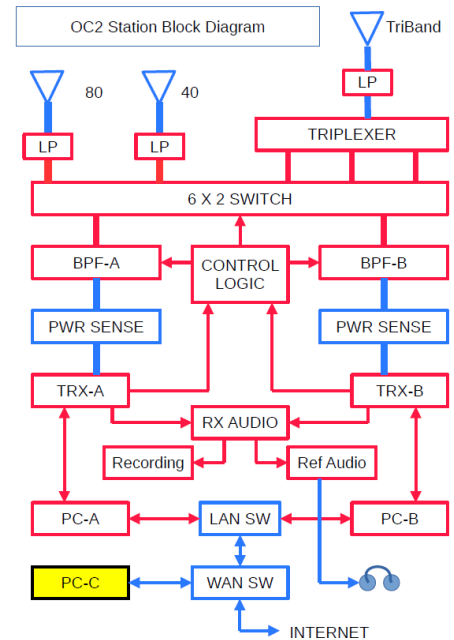

Everything in red is equipment we were bringing to Italy. Blue shows the items the Italians were supplying and we had to use. The referee would bring his own PC (yellow) and headset. So, if you think this is just two guys bringing their radios to have some fun? ... Well, think again.

Before flying to Italy, we tested the complete setup at Bob's shack during WPX CW in May. Unfortunately, we only had a few hour to do that but it was an good test. It mostly all worked as we expected, but there were a few small things that needed improvements. Tom got right to it. I was only in CA for a few days and wasn't able to stay long enough for a second test, but Don worked with Bob to test everything again during Field Day with better results.





For me, I haven't been to Europe for a couple of decades so I flew to Frankfurt early to visit friends and take in the huge ham fest at Friedrichshafen which has been a bucket list item for a long time. First I stayed a few days with an old friend Win, DK9IP who also has the call KH7CD. I'm very grateful for his hospitality. We drove to Friedrichshafen and took in the show. Everyone said the convention was just a shadow of it's usual size due to just starting again after Covid. I won't spend a lot of time describing it, except to say the social aspects were amazing. Like at Visalia, I ran into old friends I hadn't seen in many years.



Next I visited another old friend, Lars DL4JLM. I met Lars 25 years ago in San Jose when he was an EE student working for Siemens. I invited him to join NCCC as KF6ZWZ and he's been an avid contester ever since.

On July 4 it was time to drive to Bologna and check in at WRTC. It's about a 10 hour drive from east Germany. Lars and I arrived in time for dinner and joined Bob and the others for our first Italian dinner. Tom's wife Barbara joined us.



For the rest of this story, please join us Sept 12 at the Wagon Wheel NCCC meeting. If you can't make it physically, please join us on the Zoom session.

## Mammoth Meeting Held Hank, W6SX

W6SX (seated) and K6KM in Hank's shack. Roberto was in Mammoth Lakes for a few days bagging peaks. All his hard climbing earned him Summits On The Air Mountain Goat status.







## On-Line Score Reporting for N3FJP

### John, NN6U



Setting up the N3FJP contest programs to submit your score to the online scoreboards is fairly straightforward. Unlike some of the other loggers, N3FJP doesn't require you to create an account on the online scoreboard or provide a password. It uses an online score distributor to send your scores to multiple online scoreboards.

For the screenshots below, we're using N3FJP's NAQP Contest Log 5.3.4, but the steps are the same for other N3FJP loggers that support the scoreboard.

Go to "Settings" → "Web Upload Contest Status..." → "Other Online Score Sites"

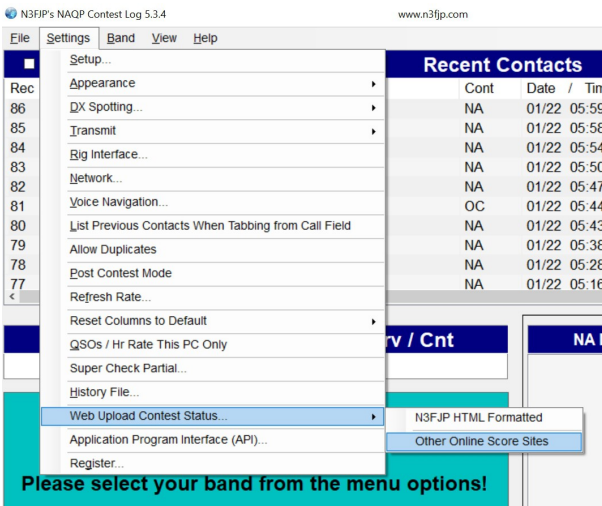

At the bottom of the form, fill in the parameters to match the category and other info you intend to use for the contest. Note that you need to fill this in here separately from when you fill in the similar form for creating the Cabrillo file for submission after the contest. See the screenshot below.

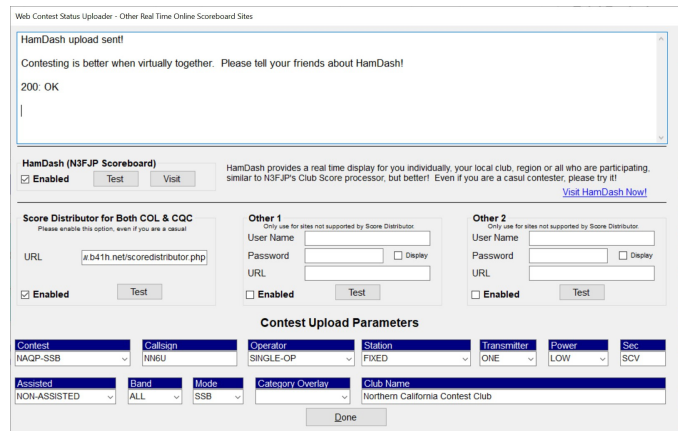

Under "Score Distributor for Both COL & CQC", click "Enabled". The URL should be filled in for you, but just in case it's missing, it should be

<http://www.b41h.net/scoredistributor.php>. Click "Test" and if everything is set correctly, the window at the top should have a message including "200: OK". If you go to <https://contestonlinescore.com/> and select the contest (possibly under "... a few more contests for you"), you can confirm that your score (probably 0) is showing up in the correct category. Here a quick link to get directly to NAQP SSB:

[https://contestonlinescore.com/scoreboard/?contest\\_id=21](https://contestonlinescore.com/scoreboard/?contest_id=21).

Back on the N3FJP form, you may want to click "Enabled" under "HamDash (N3FJP Scoreboard)". It's not related to the PVRC contest, but it's more interesting and fun, so it's worth checking out and supporting with your scores. Click "Test" and you should get another message in the window on top that says "200: OK". You can click "Visit" to go to the site, select the Contest using the button at the top, and you should see your score (probably 0 if you're setting it up before the contest). Email [john@nn6u.com](mailto:john@nn6u.com) if you need help.



## Morse Code Saves the Day

Dennis, WU6X



I've a short story to tell about how Morse Code saved the day while serving in the Navy ... After an active-duty '67-'68 tour aboard the USS Hassayampa, AO-145, one of three, giant fleet oilers capable of underway replenishment of ships in the fleet off Vietnam, for two weeks on-station, I mustered-off active duty. I decided to stay in the US Navy Reserves for a 2nd 6-year enlistment. During that reserve duty, I took the 5wpm

Novice test and received my Novice ticket, all CW for the entire first year, of course. So, I got very proficient at it as I practiced for 12wpm and the General Class ticket. Also, during that period, Navy Reservists were required to take a 2-week refresher cruise every year, which was a nice break from my civilian job. Since my rate/rank was as a Radarman Petty Officer 3rd Class, I spent my time while aboard these cruises hanging out with the Signalmen mostly, when not standing a watch in the Combat Information Center (CIC). Of course, the Signalmen all knew Morse Code, so we had something in common to talk about.



On one particular cruise to San Diego, on a destroyer out of Treasure Island, we were moored at a dock with a good view of ships coming in/out of San Diego harbor. While most everyone was ashore on liberty, I caught a Quarterdeck watch guarding the gangway. I was basically in charge of the safety of the ship for 4 hours, answering the phone, regulating and logging who came aboard, or left, if

not assigned to the ship. Well, during one watch, a shipmate came up and said there was another US Navy destroyer in the middle of the harbor signaling with flashing light, about 200 yards from our position, so I went to investigate.

As it turned out, the ship was flashing Morse code, and I began to copy without thinking too much about it, my mind making the translation from sight, to brain, to letters in Morse. Anyway, I quickly discovered they had lost power, and were now drifting with no steerage. Fortunately, it wasn't a windy day! I ran back to the Quarterdeck and called the Harbor Master who dispatched a tug to rescue







the drifting ship, and we watched the rescue drama take place.

Anyway, I logged the incident into the Quarterdeck log book and didn't think much about it. I did get a thank you call from the Harbor Master for my quick action. And, I did impress those who witnessed the event and my decode of the flashing light, everyone wondering why in the world a Radarman would know Morse Code. It was a fulfilling experience using a skill learned from Amateur Radio during a "rescue mission". Hi! I went on to practice sending with flashing light, and even learned how to use semaphore flags to send messages on subsequent cruises, ship-to-ship. And that's my "sea story" for this issue of [JUG](#).

## Tube of the Month

**Norm Wilson, N6JV**

*(Department of Thermionic Paleontology)*

Visit the Tube Museum at [n6jv.com](http://n6jv.com)

### Eimac 8877

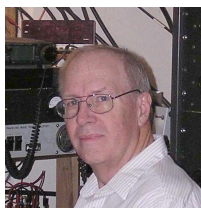

With the success of EIMAC's focused cathode tetrodes, new product lines were explored to produce truly zero bias triodes using the new technology. In 1968, a research program began with the goal of developing the construction techniques required to make tubes of this type. They started with components from existing tubes like the 4CX1500B which already had a focused cathode. They initially wanted to experiment with a range of tube sizes up to 5 KW, but decided to concentrate on the 400 and 1500-watt sizes. Initial trials with a 400-watt tube were so promising that they built a triode based on the 4CX1500B. This was also very successful and they refined the geometry of the cathode and grid to peak the performance.

A goal of the project a tube that didn't require complex and expensive socket systems, also resulting of lower production costs. The tubes of the 4CX1500B family, used the bulky breach block construction. The solution was to use a common header to hold all the pins that would fit an inexpensive existing socket. The 1500-watt triode was completed in 1969 and was designated the [8877/3CX1500A7](#). The tube could operate with 4000 VDC at 1 amp on the plate and 5 volts at 10.5 amps on the heater. Maximum frequency for full power is 250 MHz and the amplification factor is 200. The tube will work at zero bias below 3000 VDC but requires bias above that. The tube was designed to use a zener diode to provide the bias. The heater is isolated from the cathode so it doesn't require chokes in the leads to the transformer. The input impedance at the cathode is about 54 ohms so is easy to drive with solid state transceivers. The bias zener and the metering circuits are directly connected to the cathode. The socket is the 7-pin septar socket like the old 829B uses with a finger stock ring to make contact with the grid ring.



The 8877 was a big success and was adopted by several amateur radio amplifier builders. EIMAC built an amplifier that featured it in their [Amateur Service Newsletter AS-45](#) and in the September 1971 issue of QST. The most successful application for the 8877 was in MRI (Magnetic Resonance Imaging) equipment.





**ADMIT ONE**

**58th Running  
California  
QSO Party**

Here's Your Ticket To  
The Most Popular  
State QSO Party On  
The Planet!

**October 7-8, 2023**  
1600 UTC Oct 7 to 2200 UTC Oct 8



Grab a CA QSO or County  
For That New Certificate!

*Worked All States  
LoTW Triple Play  
USA Counties Award  
Worked All California Counties*

Special  
Prizes & Awards!

Complete Rules & Info:  
**CQP.org**  
Northern California Contest Club



*Excellence in Amateur Radio Contesting*



**CQP is coming!**

Check out CQP.org to see the currently planned county expeditions. Unlike many state QSO Parties, CQP is famous for activating all fifty eight (58) CA counties. Now's a great time to plan your own expedition.



## Editor Notes

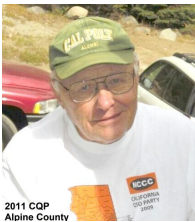

This issue offers help with On-line Scoring for the N3FJP logging program thanks to John, NN6U. It's not clear that using On-line Scoring is popular with NCCC folks, but it is required to have your scores count for NCCC in the PVRC-sponsored contest within the six NAQP's. Also not certain is how popular that contest-within-a-contest is with NCCC membership. Nonetheless, instructions for other loggers are welcome should anyone be so motivated.

In case you hadn't noticed, we are barreling into the High Contest Season, beginning with everyone's favorite ... our very own CQP! 2023 will mark the 50<sup>th</sup> anniversary of this NCCC sponsored contest on the first full weekend in October.

If you're planning a county expedition, be sure to register your county at <http://cqp.org/> CQP has a long history of activating all 58 CA counties.

## The Solar X-Ray Machine

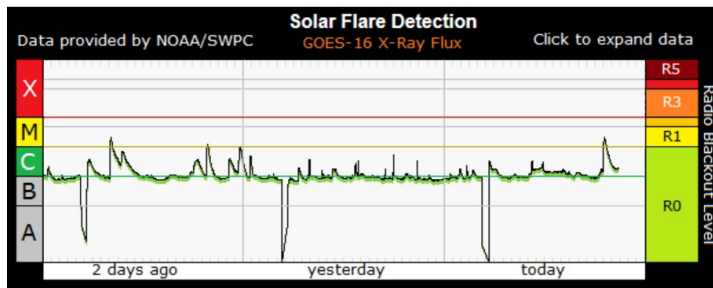

Ever wonder what those deep negative excursions in the solar X-Ray flux are? Well, the chart is produced from data from one of the GOES satellites in geostationary orbit over the equator. For nearly all of the year, from that altitude (~22,000 mi), the satellite has an unobstructed view of the sun. Twice a year however, as the earth approaches the equinox (where its orbital path intersects the ecliptic plane), the satellite falls into the Earth's shadow for a short period

each day, blocking all data collection. We're approaching the autumnal equinox on or near 21 Sep as the Earth falls "below" the ecliptic and winter ensues in the northern hemisphere. Next year, mid Mar thru mid Apr, we'll again pass through the ecliptic the other way at the vernal equinox and this effect will happen again. The X-Ray flux from the sun doesn't change, just GOES' view of it, so nothing happens on the radio.



## NCCC Membership Information

If you wish to join NCCC, please fill out an application for membership, which will be read and voted upon at our monthly meeting. To join, you must reside within club territory which is defined as everything in California north of the Tehachapi's up to the Oregon state line, and part of northwestern Nevada (anything within our ARRL 175-mile radius circle centered at 10 miles north of Auburn on Highway 49).

## Life Memberships

Life memberships are \$250.00 Contact [secretary.nccc@gmail.com](mailto:secretary.nccc@gmail.com). Members who have reached 80 years of age have and been an NCCC member for 20 or more years are eligible for Honorary Life Membership ("80/20 Rule"). Contact [secretary.nccc@gmail.com](mailto:secretary.nccc@gmail.com)

## JUG Articles Wanted!

Your help allows us to produce a quality newsletter. Please consider submitting an article! The editor welcomes any and all relevant articles for inclusion in the JUG. The preferred format is plain, unformatted ASCII text, MS Word (.doc/.docx) are acceptable. Indicate the insertion point and title of diagrams and pictures in the text and attach photos/diagrams separately. Pictures should be as high a resolution as available. Please do not spend time formatting your submittal, the publication templates will re-format everything. Send your material to [k6dgwnv@gmail.com](mailto:k6dgwnv@gmail.com) indicating "JUG Submittal" in the subject.

## Northern California Contest Club Reflector—Guidelines

The NCCC email reflector is devoted to the discussion of contesting. Topics include contests, station building, dxpeditions, technical questions, contesting questions, amateur radio equipment wants/sales, score posting, amateur radio meetings/ conventions, and membership achievements. Postings may not include personal attacks, politics, or off-subject posts. Such postings will be considered a violation of the Guidelines

## Find NCCC on Social Media

Facebook: "Northern California Contest Club"

Twitter: "NCCCCKB"





**LANDS' END**  
BUSINESS

Search



<https://business.landsend.com/store/nccc/>

MEN WOMEN PROMOTIONAL PRODUCTS

Welcome to the NCCC Land's End store. You can choose many different products and add a custom-embroidered NCCC logo.

If you would like to add your name and/or call sign, click the Add Personalization button when designing your garment (\$8 charge, 10 character limit).

If you have questions, contact the NCCC secretary at: [secretary.nccc@gmail.com](mailto:secretary.nccc@gmail.com)



**Northern California Contest Club**

### [NCCC Lands' End Store](#)

We are pleased to announce that the new NCCC Land's End store is online! You can choose from an array of shirts, jackets, and hats and apply your choice of custom-embroidered NCCC logos: A plain one, or one that also says Fifty Years. And, you can personalize your item by adding your name and/or call sign. The store is open 24/7 and items are shipped directly to you. No more waiting for everyone else to make up their minds on a group purchase.

<https://business.landsend.com/store/nccc/> or from the NCCC website: <http://nccc.ccc/members/lestore.html>

Thanks to W6TCP for helping to set this up. Instructions for purchases from Lands' End NCCC Store

1. Go to <https://business.landsend.com/store/nccc/>
2. Click on Men's or Women's link, then choose item(s)
3. Pick color, inter quantity of each size you want to order.
4. Click Apply Logos and Personalizations. This will display the logo choices. Try them out. It will show you what they look like on your chosen fabric color.
5. Select a location for logo (left side, ride side, back, etc)
6. Click Apply Logo.
7. Optionally, click Add Personalization to add your name or call sign (\$8.00, 10 character limit)
8. Click Add to Bag and Continue Shopping or.



# Northern California Contest Club

Excellence In Amateur Radio Contesting

## K4 HIGH-PERFORMANCE DIRECT SAMPLING SDR



### A direct-sampling SDR you'll love to use

Our new K4 transceiver harnesses advanced signal processing while retaining the best aspects of the K3S and P3. It features a 7" touch display, plus a rich set of dedicated controls. Per-VFO transmit metering makes split mode foolproof. Band-stacking registers and per-receiver settings are versatile and intuitive. Control usage information is just one tap away thanks to a built-in help system.

### Modular, hybrid architecture adapts to your needs

The basic K4 covers 160-6 m, with dual receive on the same or different bands. The K4D adds diversity receive, with a full set of band-pass filters for the second receiver. (Thanks to direct RF sampling, there's no need for crystal filters in either the K4 or K4D.) The K4HD adds a dual superhet module for extreme-signal environments. Any K4 model can be upgraded to the next level, and future enhancements—such as a planned internal VHF/UHF module—can be added as needed.

### Single or dual panadapter, plus a high-resolution tuning aid

The main panadapter can be set up as single or dual. Separate from the main panadapter is our per-receiver *mini-pan* tuning aid, with a resampled bandwidth as narrow as +/- 1 kHz. You can turn it on by tapping either receiver's S-meter or by tapping on a signal of interest, then easily auto-spot or fine tune to the signal.

### Comprehensive I/O, plus full remote control

The K4's rear panel includes all the analog and digital I/O you'll ever need. All K-line accessories are supported, including amps, ATUs, and our K-Pod controller. The Video output can mirror the K4 screen or display a high-res Panadapter only screen. Via Ethernet, the K4 can be 100% remote controlled from a PC, notebook, tablet, or even another K4, with panadapter data included in all remote displays. Work the world from anywhere—in style!

### K4 KEY FEATURES

Optimized for ease of use

Modular, upgradeable design

7" color screen with touch and mouse control

ATU with 10:1+ range, 3 antenna jacks

Up to 5 receive antenna sources

Full remote control via Ethernet



The K4 interfaces seamlessly with the KPA500 and KPA1500 amplifiers

*'The performance of their products is only eclipsed by their service and support. Truly amazing!'* Joe - W1GO



For complete features and specifications visit [elecraft.com](http://elecraft.com) • 831-763-4211

Start Secure Check out. Account creation and credit card required.



# Northern California Contest Club

Excellence In Amateur Radio Contesting

# HAM RADIO OUTLET®

WWW.HAMRADIO.COM

**\*Free Shipping and Fast Delivery!**



**IC-9700 | All Mode Tri-Band Transceiver**  
 • VHF/UHF/1.2GHz • Direct Sampling Now Enters the VHF/UHF Arena • 4.3" Touch Screen Color TFT LCD • Real-Time, High-Speed Spectrum Scope & Waterfall Display • Smooth Satellite Operation



**IC-718 | HF Transceiver**  
 • 160-10M\*\* • 100W • 12V operation • Simple to use • CW Keyer Built-in • One touch band switching • Direct frequency input • VOX Built-in • Band stacking register • IF shift • 101 memories



**IC-V3500 | 144MHz FM Mobile**  
 • 65W of Power for Long Range Communications • 4.5 Watts Loud & Clear Audio • Modern White Display & Simple Operation • Weather Channel Receive & Alert Function



**IC-7851 | HF/50MHz Transceiver**  
 • 1.2kHz "Optimum" roofing filter • New local oscillator design • Improved phase noise • Improved spectrum scope • Dual scope function • Enhanced mouse operation for spectrum scope



**IC-705 | HF/50/144/430 MHz All Mode Transceiver**  
 • RF Direct Sampling • Real-Time Spectrum Scope and Waterfall Display • Large Color Touch Screen • Supports QRP/ORPp • Bluetooth® and Wireless LAN Built-in



**IC-2300H | VHF FM Transceiver**  
 • 65W RF Output Power • 4.5W Audio Output • MIL-STD 810 G Specifications • 207 alphanumeric Memory Channels • Built-in CTCSS/DTCS Encode/Decode • DMS



**IC-7300 | HF/50MHz Transceiver**  
 • RF Direct Sampling System • New "IP+" Function • Class Leading RMDR and Phase Noise Characteristics • 15 Discrete Band-Pass Filters • Built-In Automatic Antenna Tuner



**IC-7100 | All Mode Transceiver**  
 • HF/50/144/430/440 MHz Multi-band, Multi-mode, IF DSP • D-STAR DV Mode (Digital Voice + Data) • Intuitive Touch Screen Interface • Built-in RTTY Functions

**IC-V86 | VHF 7W HT**

• 7W Output Power Plus New Antenna Provides 1.5 Times More Coverage • More Audio, 1500 mW Audio Output • IP54 & MIL-STD 810G-Rugged Design Against Dust & Water • 19 Hours of Long Lasting Battery Life • 200 Memory Channels, 1 Call Channel & 6 Scan Edges



**IC-7610 | HF/50 MHz All Mode Transceiver**  
 • Large 7-inch color display with high resolution real-time spectrum scope and waterfall • Independent direct sampling receivers capable of receiving two bands/two modes simultaneously



**IC-2730A | VHF/UHF Dual Band Transceiver**  
 • VHF/VHF, UHF/UHF simultaneous receive • 50 watts of output on VHF and UHF • Optional VS-3 Bluetooth® headset • Easy-to-See large white backlight LCD • Controller attachment to the main Unit

**NEW**



**IC-T10 | Rugged 144/430 MHz Dual Band**  
 • Disaster Ready - Excellent Fit for Your Emergency Bag • Loud Audio - New Speaker Design • Long Battery Life - Up to 11 Hours • FM Broadcast & Weather Channels



**IC-R8600 | Wideband SDR Receiver**  
 10 kHz to 3 GHz Super Wideband Coverage • Real-time Spectrum Scope w/Waterfall Function • Remote Control Function through IP Network or USB Cable • Decodes Digital Incl P25, NXDN™, D-STAR • SD Card Slot for Receiver Recorder



**ID-5100A Deluxe VHF/UHF Dual Band Digital Transceiver**  
 • Analog FM/D-Star DV Mode • SD Card Slot for Voice & Data Storage • 50W Output on VHF/UHF Bands • Integrated GPS Receiver • AM Airband Dualwatch

**ID-52A | VHF/UHF D-STAR Portable**

• Bluetooth® Communication • Simultaneous Reception in VV, UV, WU and DV/DV • Enriched D-STAR® Features Including the Terminal Mode/Access Point Mode • UHF (225-374.995MHz) Air Band Reception



- RETAIL LOCATIONS - Store hours 10:00AM - 5:30PM - Closed Sunday
- PHONE - Toll-free phone hours 9:30AM - 5:30PM
- ONLINE - WWW.HAMRADIO.COM
- FAX - All store locations
- MAIL - All store locations



**FOLLOW HRO ON SOCIAL MEDIA**



twitter.com/HamRadioOutlet  
 facebook.com/HROHamRadioOutlet  
 instagram.com/HamRadioOutlet  
 youtube.com/HamRadioOutlet

\*On most orders over \$100 in the continental US. (Rural locations excluded) \*\*Except 60W Band. The Icom logo is a registered trademark of Icom Inc. Toll-free including Hawaii, Alaska and Canada. All HRO 800-lines can assist you if the first line you call is busy, you may call another. Prices, specifications and descriptions subject to change without notice.





# Northern California Contest Club

Excellence In Amateur Radio Contesting

# HAM RADIO OUTLET

WWW.HAMRADIO.COM

**See us at HAMCATION Booth 024-028!**



**FTDX101MP | 200W HF/50MHz Transceiver**

- Hybrid SDR Configuration • Unparalleled 70 dB Max. Attenuation VC-Tune • New Generation Scope Display 3DSS • ABI (Active Band Indicator) & MPVD (Multi-Purpose VFO Outer Dial) • PC Remote Control Software to Expand the Operating Range • Includes External Power With Matching Front Speaker



**FT-710 Aess | HF/50MHz 100W SDR Transceiver**

- Unmatched SDR Receiving Performance • Band Pass Filters Dedicated for the Amateur Bands • High Res 4.3-inch TFT Color Touch Display • AESS: Acoustic Enhanced Speaker System with SP-40 For High-Fidelity Audio • Built-in High Speed Auto Antenna Tuner



**FTM-400XD | 2M/440 Mobile**

- Color display-green, blue, orange, purple, gray • GPS/APRS • Packet 1200/9600 bd ready • Spectrum scope • Bluetooth • MicroSD slot • 500 memory per band



**FTDX10 | HF/50MHz 100 W SDR Transceiver**

- Narrow Band and Direct Sampling SDR • Down Conversion, 9MHz IF Roofing Filters Produce Excellent Shape Factor • 5" Full-Color Touch Panel w/3D Spectrum Stream • High Speed Auto Antenna Tuner • Microphone Amplifier w/3-Stage Parametric Equalizer • Remote Operation w/optional LAN Unit (SCU-LAN10)



**FT-891 | HF+50 MHz All Mode Mobile Transceiver**

- Stable 100 Watt Output • 32-Bit IF DSP • Large Dot Matrix LCD Display with Quick Spectrum Scope • USB Port Allows Connection to a PC with a Single Cable • CAT Control, PTT/RTTY Control



**FT-70DR C4FM/FM 144/430MHz Xcvr**

- System Fusion Compatible • Large Front Speaker delivers 700 mW of Loud Audio Output • Automatic Mode Select detects C4FM or Fm Analog and Switches Accordingly • Huge 1,105 Channel Memory Capacity • External DC Jack for DC Supply and Battery Charging



**FT-991A | HF/VHF/UHF All Mode Transceiver**

- Real-time Spectrum Scope with Automatic Scope Control • Multi-color waterfall display • State of the art 32-bit Digital Signal Processing System • 3kHz Roofing Filter for enhanced performance • 3.5 inch Full Color TFT USB Capable • Internal Automatic Antenna Tuner • High Accuracy TCXO



**FTM-300DR | C4FM/FM 144/430MHz Dual Band**

- 50W Output Power • Real Dual Band Operation • Full Color TFT Display • Band Scope • Built-in Bluetooth • WIRES-X Portable Digital Node/Host Node with HRI-200



**FT-5DR C4FM/FM 144/430 MHz Dual Band**

- High-Res Full-Color Touch Screen TFT LCD Display • Easy Hands-Free Operation w/Built-In Bluetooth® Unit • Built-In High Precision GPS Antenna • 1200/9600bps APRS Data Communications • Supports Simultaneous C4FM Digital • Micro SD Card Slot



**FTDX101D | HF + 6M Transceiver**

- Narrow Band SDR & Direct Sampling SDR • Crystal Roofing Filters Phenomenal Multi-Signal Receiving Characteristics • Unparalleled -70dB Maximum Attenuation VC-Tune • 15 Separate (HAM 10 + GEN 5) Powerful Band Pass Filters • New Generation Scope Displays 3-Dimensional Spectrum Stream



**FT-2980R | Heavy-Duty 80W 2M FM Transceiver**

- 80 watts of RF power • Large 6 digit backlit LCD display for excellent visibility • 200 memory channels for serious users



**FT-65R | 144/430 MHz Transceiver**

- Compact Commercial Grade Rugged Design • Large Front Speaker Delivers 1W of Powerful Clear Audio • 5 Watts of Reliable RF Power Within a compact Body • 3.5-Hour Rapid Charger Included • Large White LED Flashlight, Alarm and Quick Home Channel Access



**FTM-200DR | C4FM/FM 144/430MHz Dual Band**

- 1200/9600bps APRS® Data Communications • 2" High-Res Full-Color TFT Display • High-Speed Band Scope • Advanced C4FM Digital Mode • Voice Recording Function for TX/RX



**FTM-6000R | 50W VHF/UHF Mobile Transceiver**

- All New User Operating Interface-E20-II (Easy to Operate-III) • Robust Speaker Delivers 3W of Clear, Crisp Receive Audio • Detachable Front Panel Can Be Mounted in Multiple Positions • Supports Optional Bluetooth® Wireless Operation Using the SSM-BT10 or a Commercially Available Bluetooth® Headset



- RETAIL LOCATIONS – Store hours 10:00AM - 5:30PM - Closed Sunday
- PHONE – Toll-free phone hours 9:30AM - 5:30PM
- ONLINE – WWW.HAMRADIO.COM
- FAX – All store locations
- MAIL – All store locations

**YAESU**  
The radio

SACRAMENTO, CA (877) 892-1745	PORTLAND, OR (800) 765-4267	PHOENIX, AZ (800) 559-7388	MILWAUKEE, WI (800) 558-0411	WOODBIDGE, VA (800) 444-4799	WINTER SPRINGS, FL (800) 327-1917
SAN DIEGO, CA (877) 520-9623	DENVER, CO (800) 444-9476	ATLANTA, GA (800) 444-7927	NEW CASTLE, DE (800) 644-4476	SALEM, NH (800) 444-0047	<b>WWW.HAMRADIO.COM</b>

Contact HRO for promotion details. Toll-free including Hawaii, Alaska and Canada. All HRO 800-lines can assist you. If the first line you call is busy, you may call another. Prices, specifications and descriptions subject to change without notice.